

TOTEM

FOYERS DE CHEMINÉE | FIREPLACES

LA VISION INTÉGRALE DU FEU
A TOTAL VIEW OF FIRE





sommaire

gamme **classic**

foyers droits straight fireplaces	p.7
foyers multifaces multisided fireplaces	p.15
foyers galbés curved fireplaces	p.21
foyers recto-verso séparatifs separating double sided fireplaces	p.27
foyers recto-verso centraux central double sided fireplaces	p.31
foyers suspendus suspended fireplaces	p.35

gamme **technika**

frontal 800	p.40
latéral 800	p.42
3 faces 800	p.44
épi 800	p.46
4 faces suspendu	p.48

accessoires | *accessories*

système de suspension <i>suspension</i> system	p.52
les cadres de finition frames	p.54

caractéristiques techniques | *technical features*

synoptique de la gamme totem	p.58
synoptic of the totem range	
schéma dynamique dynamic drawing	p.62

LE SAVOIR-FAIRE FRANÇAIS A



UN SERVICE DE VOTRE PROJET

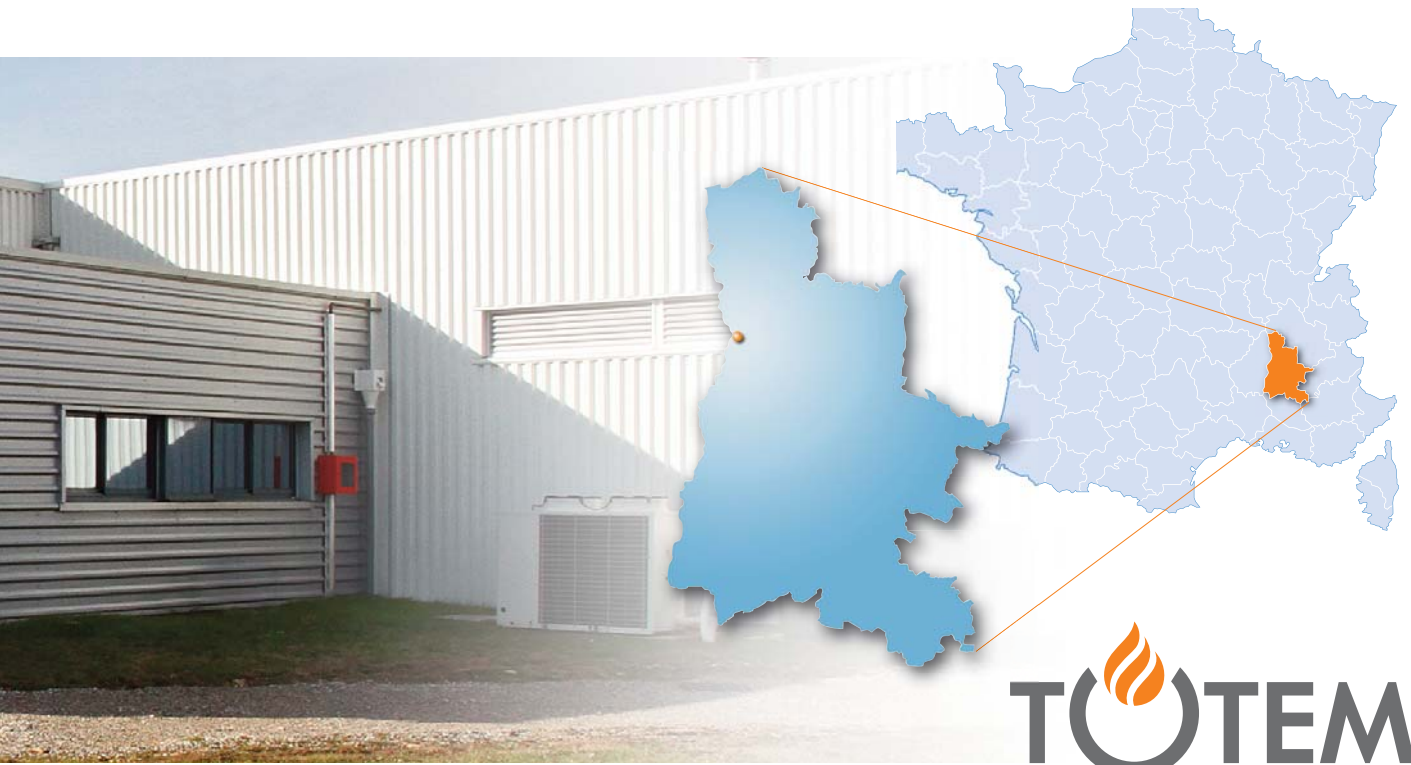

MADE IN FRANCE
MADE IN DRÔME
MADE IN VALENCE

Entreprise à taille humaine entièrement dédiée à un métier et un seul : **la fabrication de foyers de cheminées de grande qualité.**

Depuis plus de vingt ans, nous concevons et produisons nos foyers avec cette exigence permanente de qualité et de fiabilité, expression de notre compétence artisanale.

Pièce unique, créée pour vous, votre foyer TOTEM sera **l'élément central** de votre future cheminée.

*A company on human scale entirely dedicated to one sole business: **the manufacture of top quality fireplaces.***

For over twenty years we have been designing and producing fireplaces with constant demand for quality and reliability,

the very expression of our craftsman skills.

*A unique product, created just for you, your TOTEM hearth will be **the focal point** of your future fireplace*

gamme classic

Les foyers Totem de la gamme **classic** sont disponibles en **2 versions** : standard ou boîte à fumée.

1- La version **standard, la plus aboutie** de nos foyers, propose un équipement complet comprenant :

- le carénage enveloppant le foyer qui optimise la récupération de chaleur grâce à ses 4 bouches de distribution d'air chaud ;
- la boîte à fumée qui offre une protection contre les éventuels refoulements à l'ouverture de la porte.

2- La version **boîte à fumée**, perd le carénage enveloppant et ses 4 bouches de distribution d'air chaud. Le reste de l'équipement est le même qu'en standard.

Les foyers Totem **classic** sont idéals **pour la rénovation** de votre maison. Chaque foyer est fabriqué avec le même **niveau d'exigence et de qualité** (choix des aciers, montage, briquetage, peinture de finition, etc...), ce qui vous garantit un appareil **fiable, efficace et performant** pour la rénovation..

1- Standard



2- Boîte à fumée



The TOTEM CLASSIC range fireplaces are available in **2 versions**: standard or smoke trap

1- The **standard** version, **the most completed** integrates the following elements:

- the cover all around the fireplace with 4 hot air vents
- the smoke trap so as to prevent from smoke backflow while opening the doors of the fireplace

2- The **smoke trap** version has no cover, no 4 hot air vents but remains with the smoke trap equipment.

The TOTEM CLASSIC range fireplaces are perfect for buildings or houses to be **renovated**. Each fireplace is made with the **same level of requirement and quality** (selection of the steel, the assembly, the bricks, the finishing paint, etc...) to ensure and provide a **reliable appliance, efficient and effective** for the refurbishment.





vivre autour
du feu
*Live around
fire*

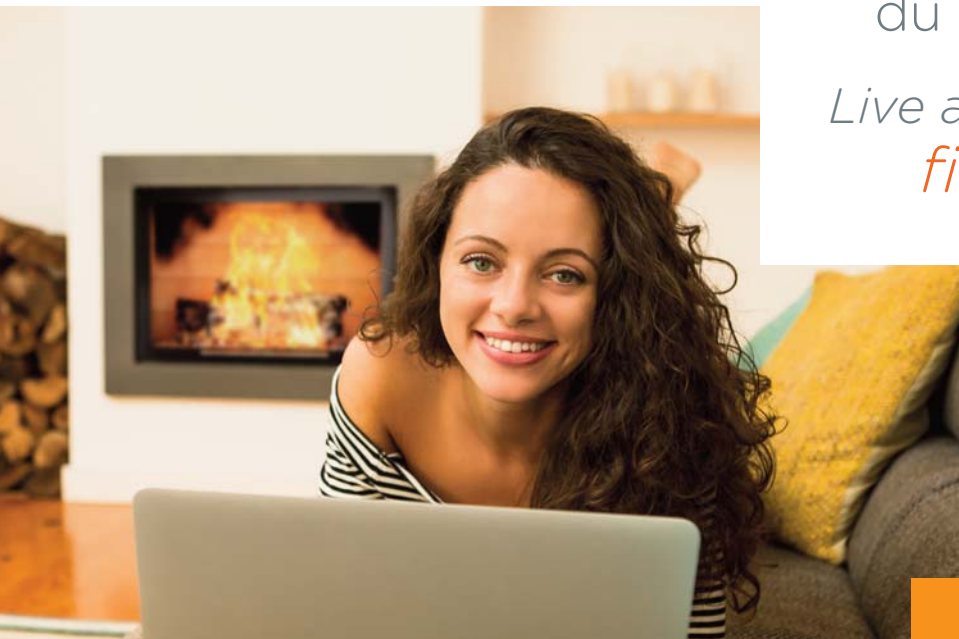

FOYERS

DROITS

g a m m e c l a s s i c

STRAIGHT

FIREPLACES



foyers droits | *straight fireplaces*

frontal

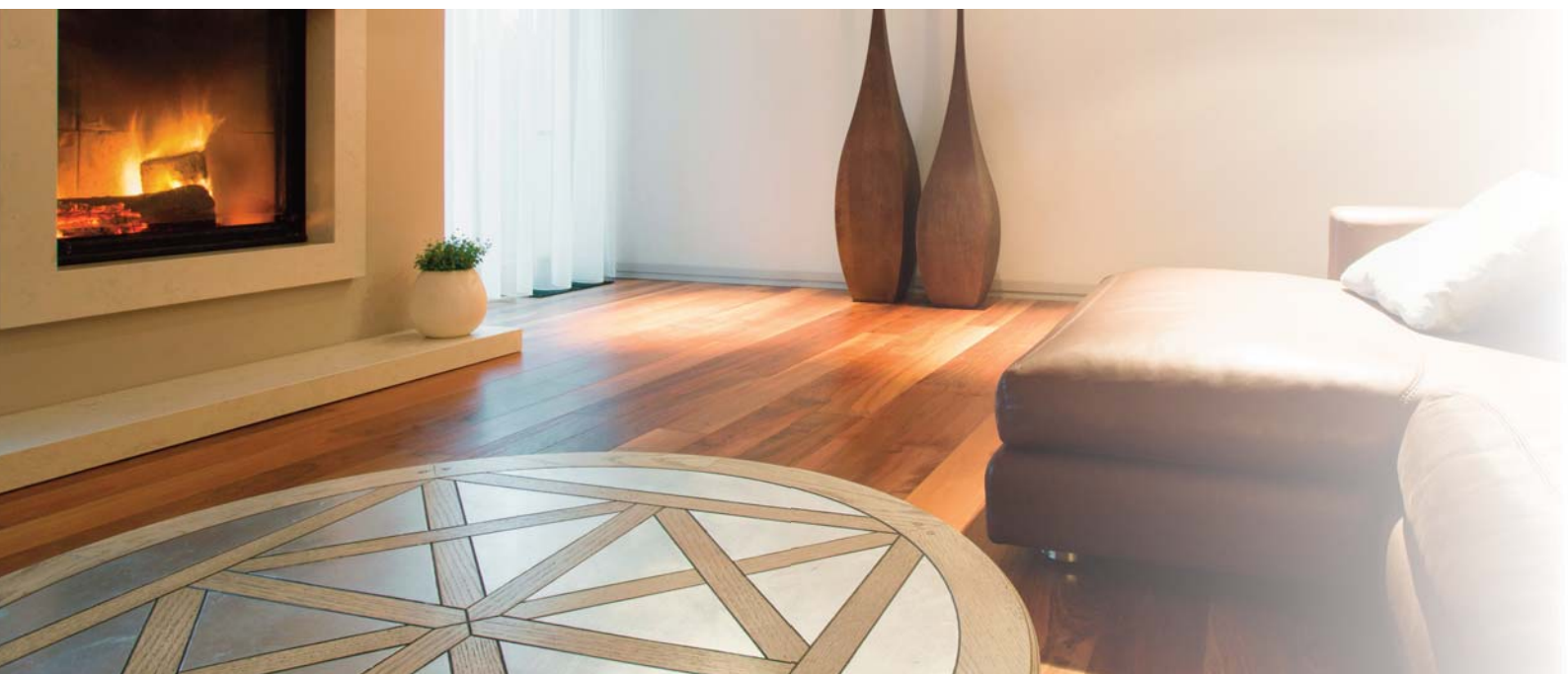
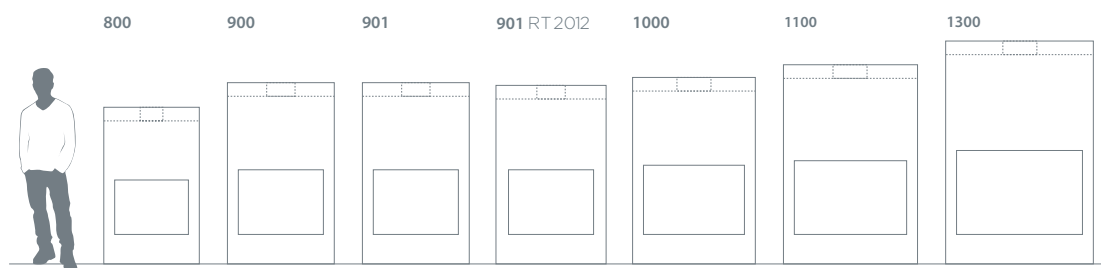



foyers droits | *straight* fireplaces

horizon

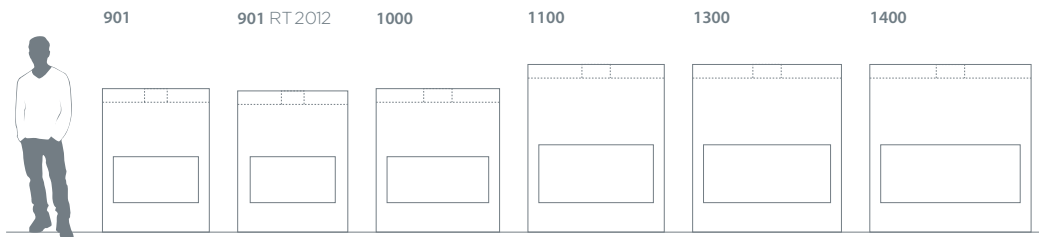



foyers droits | straight fireplaces

vertivision

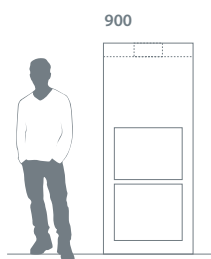

*"Vastes Forêts, Forêts magnifiques et fortes,
Quel infaillible instinct nous ramène toujours
Vers vos vieux troncs drapés de mousses de velours
Et vos étroits sentiers feutrés de feuilles mortes?"*

Albert Samain







FOYERS
MULTI-
FACES
MULTISIDED
FIREPLACES



foyers *multifaces* | *multisided* fireplaces

latéral

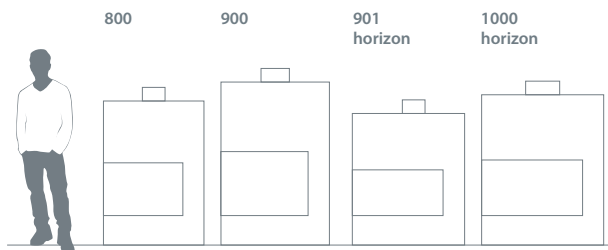



foyers *multifaces* | *multisided* fireplaces

3 faces

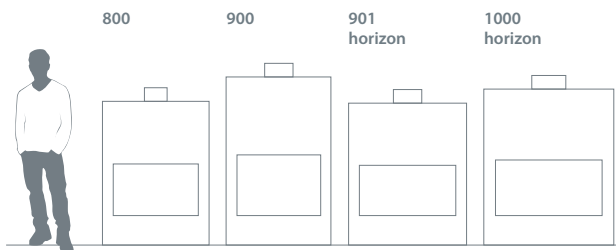





FOYERS

GALBÉS

CURVED

FIREPLACES



foyers galbés | *curved fireplaces*

panoramique

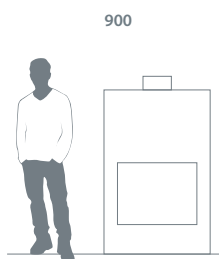



foyers galbés | *curved fireplaces*

galbé latéral

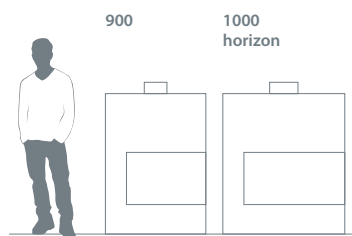





FOYERS
RECTO VERSO
SÉPARATIFS
SEPARATING
DOUBLE SIDED
FIREPLACES



foyers *rect-verso séparatifs* | *separating double sided fireplaces*

R° frontal V° battant

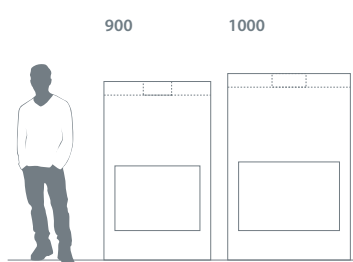

R° horizon V° battant

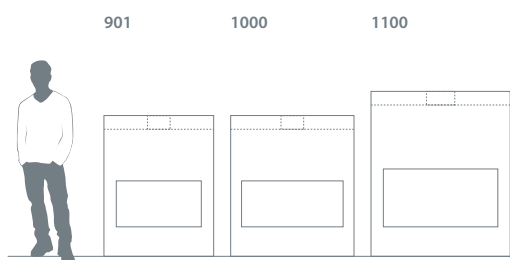



foyers *rect-verso séparatifs* | *separating double sided fireplaces*

R° vertivision V° battant

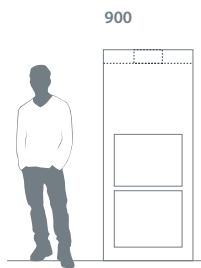

FOYERS
RECTO VERSO
CENTRAUX
CENTRAL
DOUBLE SIDED
FIREPLACES



foyers *rect-verso centraux* | *central double sided fireplaces*

R° V° frontal

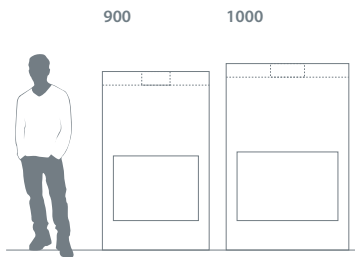





F O Y E R S
S U S P E N D U S
S U S P E N D E D
F I R E P L A C E S



4 faces suspendu

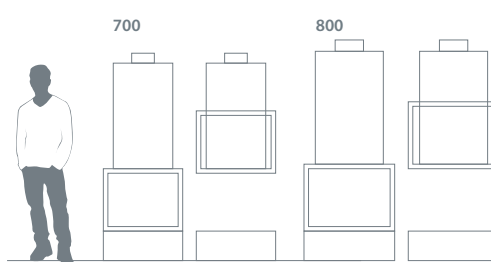

Panoramique suspendu

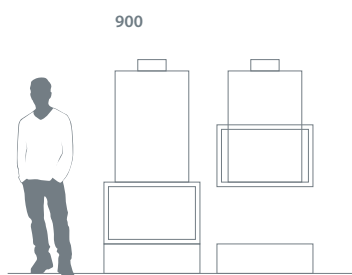





vous et votre foyer
pour des feux éco-responsables
*You and your fireplace
for Eco-friendly fires*

gamme **technika**

Grâce à leur **système d'air indépendant** et leur **qualité d'étanchéité** les foyers Technika sont utilisables dans toutes les situations y compris dans les maisons labélisées BBC* ou RT 2012.

Pour garantir un fonctionnement totalement indépendant de l'environnement dans lequel ils sont installés, les foyers Technika ont été dotés des dernières innovations Totem en matière d'étanchéité (l'ensemble des joints ayant été repensé). Ceci permet d'obtenir une **combustion de très grande qualité** et des **performances remarquables** (quantité de bois brûlé/chaaleur obtenue).



** Batiment Basse Consommation*



Because of their independent air system and excellent sealing properties the Technika fireplaces can be used in all situations including in houses approved "Buildings with reduced consumption" and RT 2012 (Thermal Regulations 2012).

To guarantee a smooth running totally independent of the environment in which they are installed, Technika fireplaces benefit from Totem's latest innovations in terms of sealing. (All gaskets have been re-designed). All this allows obtaining high quality combustion and remarkable performances. (quantity of wood burned / heat obtained)

** Buildings with reduced energy consumption*



foyers droits | *straight fireplaces*

frontal 800

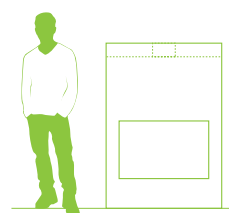

horizon 800

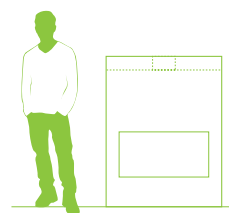



foyers multifaces | *multisided fireplaces*

latéral 800

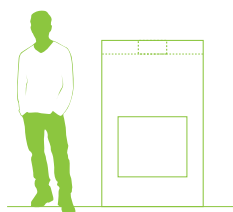



foyers multifactes | *multisided fireplaces*

3 faces 800

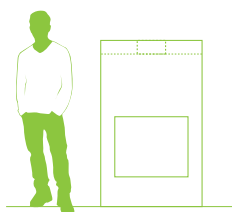



foyers multifaces | *multisided fireplaces*

épi 900

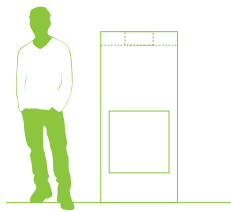



foyers suspendus | *suspended fireplaces*

4 faces **suspendu**

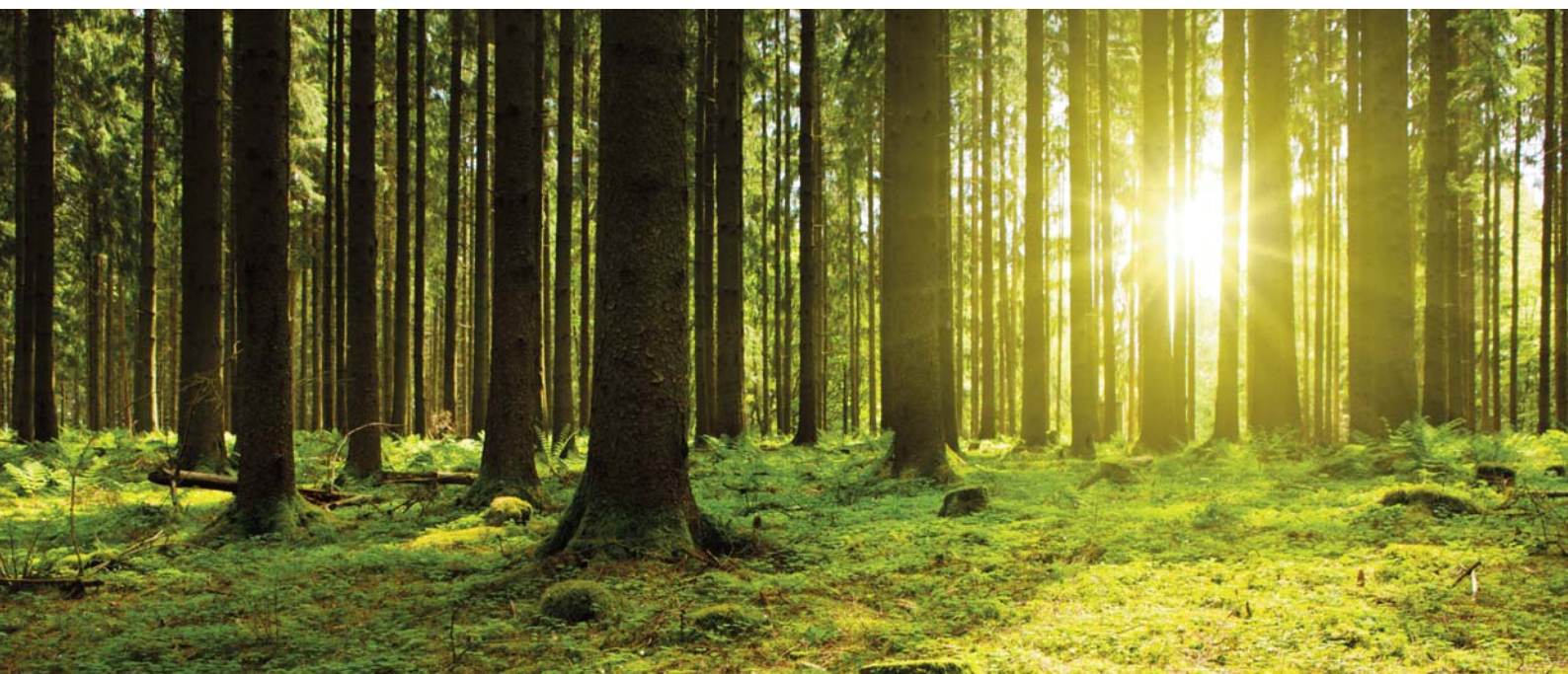
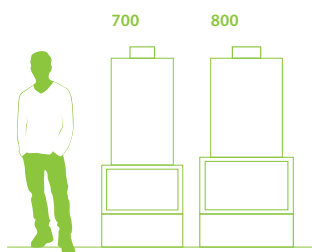





ACCESSOIRES ACCESSORIES

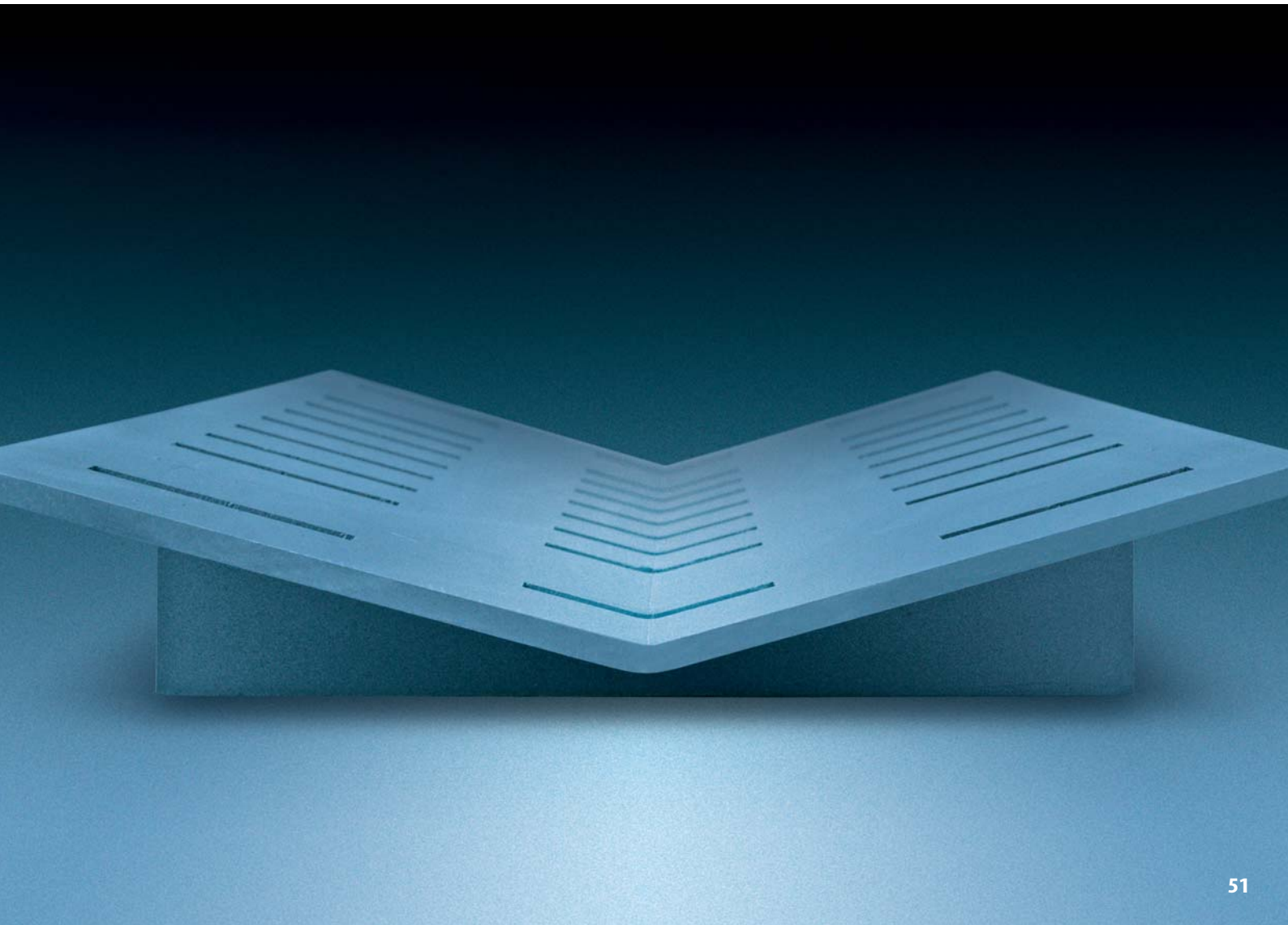

systeme de suspension

simple, pratique et efficace,
l'outil indispensable pour la pose des foyers suspendus.

suspension system

easy, useful, and efficient,
The essential tool to install the hanging fireplaces.

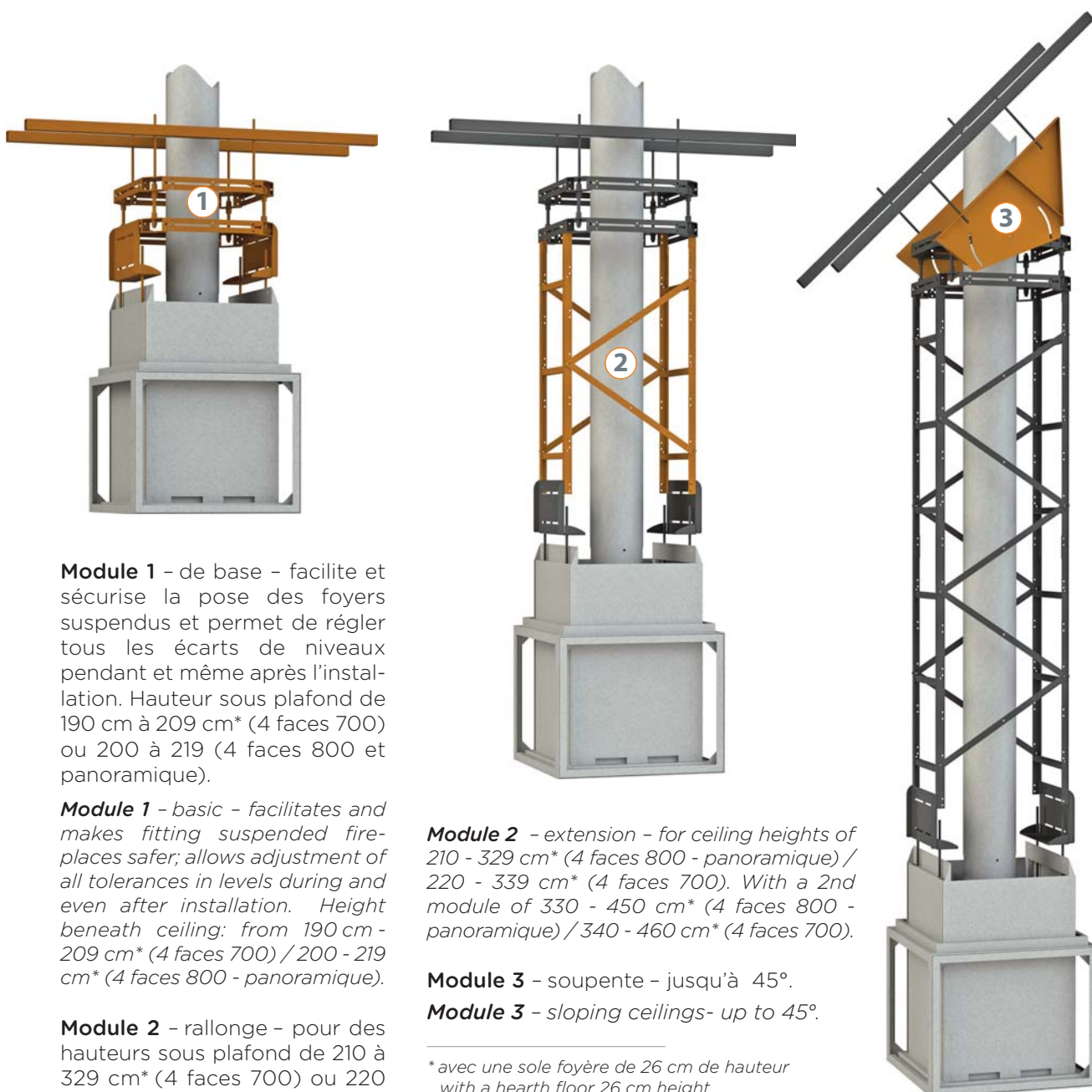

Module 1 - de base - facilite et sécurise la pose des foyers suspendus et permet de régler tous les écarts de niveaux pendant et même après l'installation. Hauteur sous plafond de 190 cm à 209 cm* (4 faces 700) ou 200 à 219 (4 faces 800 et panoramique).

Module 1 - basic - facilitates and makes fitting suspended fireplaces safer; allows adjustment of all tolerances in levels during and even after installation. Height beneath ceiling: from 190 cm - 209 cm* (4 faces 700) / 200 - 219 cm* (4 faces 800 - panoramique).

Module 2 - rallonge - pour des hauteurs sous plafond de 210 à 329 cm* (4 faces 700) ou 220 à 339 cm* (4 faces 800 et panoramique) et de 330 à 450 cm* (4 faces 700) ou 340 à 460 cm* (4 faces 800 et panoramique) avec un deuxième module 2.

Module 2 - extension - for ceiling heights of 210 - 329 cm* (4 faces 800 - panoramique) / 220 - 339 cm* (4 faces 700). With a 2nd module of 330 - 450 cm* (4 faces 800 - panoramique) / 340 - 460 cm* (4 faces 700).

Module 3 - soupente - jusqu'à 45°.

Module 3 - sloping ceilings - up to 45°.

* avec une sole foyer de 26 cm de hauteur
with a hearth floor 26 cm height

En option, le nouveau cadre linea pour foyer suspendu vous permet d'assurer la finition et le soutien de la hotte.

As an option, the new Linea frame for suspended fireplaces allows you to ensure the finishing and the support of the hood.



les cadres | frames

classik

Acier 20/10^e plié puis soudé
finition peinture haute température
*20/10^e folded and welded steel
High temperature paint finish*

Disponibles en 2 coloris
Available in 2 colours



classik
100

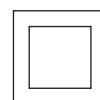

classik
50

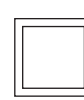

zen

Acier 20/10^e plié puis soudé
finition peinture haute température
*20/10^e folded and welded steel
High temperature paint finish*

Disponibles en 2 coloris
Available in 2 colours



zen **50**



zen **25**



Les cadres classik et zen peuvent équiper tous nos foyers droits.

Classik and Zen frames are available for all our straight fireplaces and all our double sided fireplaces.



les cadres | frames

optima

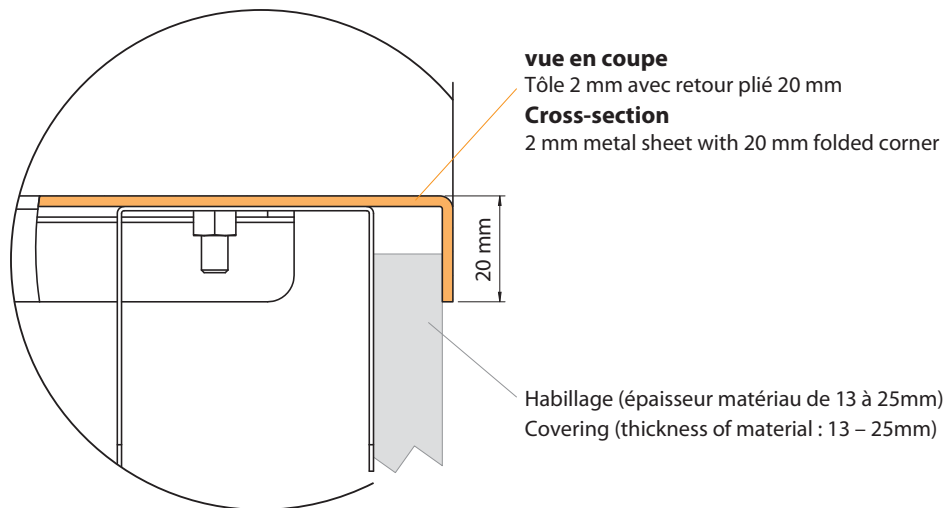

linea

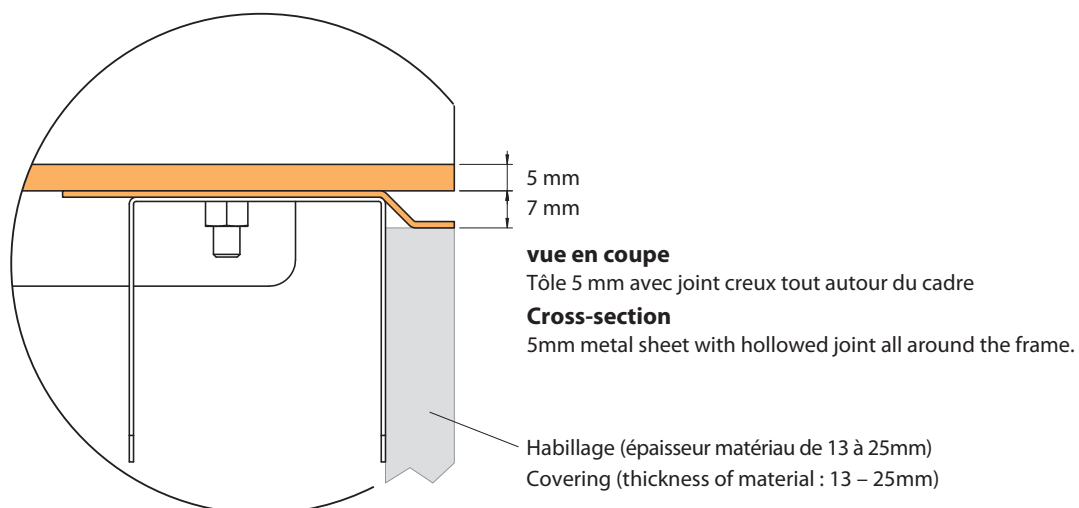

Disponibles en 2 coloris
Available in 2 colours



Les cadres optima et linea peuvent équiper tous nos foyers multifaces.
Optima and linea frames are available for all our multi sided fireplaces.



synoptique de la gamme totem

● Equipement de base
By default- Free

○ En option
Option- Charged

Disponibles en 2 coloris
Available in 2 colours



	dimensions en cm / dimensions in cm				pois en kg Weight in kg	performances / Performance				
	dimensions hors tout : hauteur x largeur x profondeur buitenafmetingen: hoogte x breedte x diepte	âtre : largeur x profondeur hearth: width x depth	hauteur de vision de feu Fire viewing height	Ø sortie de fumées Ø Smoke vent		rendement en % Yield in %	puissance annoncée en kW Stated power in kW	Taux de CO en % Rate of CO in %	taux poussières en mg/nm ³ Rate of dust in mg/nm ³	Classe d'efficacité énergétique Energy Efficiency Class
foyers droits straight fireplaces										
frontal										
frontal 800	1405 x 842 x 581	650 x 367	474	200	260	73	9 → 13,5	0,14	28,00	A
frontal 800 technika	1456 x 1019 x 578	790 x 335	508	200F	380	77	9 → 13	0,056	23,00	A
frontal 900	1598 x 942 x 628	750 x 414	570	250	360	75	9,5 → 14	0,11	27,00	A
frontal 901	1598 x 942 x 554	750 x 340	570	200	320	71,4	11,5 → 17,3	0,12	56,40	A
frontal 901 RT	1574 x 971 x 532	750 x 337	570	200F	320	81,6	8 → 12	0,08	27,70	A
frontal 1000	1668 x 1082 x 678	890 x 464	605	300	430	71	13,5 → 20	0,06	51,00	A
frontal 1100	1780 x 1182 x 686	990 x 472	650	300	520	73	12 → 18	0,23		A
frontal 1300	1985 x 1302 x 778	1110 x 564	765	300	630	73	12 → 18	0,23		A
horizon										
horizon 800 technika	1236 x 1019 x 578	790 x 335	398	180F	360	77	7 → 9	0,056	23,00	A
horizon 901	1265 x 943 x 555	750 x 340	405	200	300	71,4	11,5 → 17,3	0,12	56,40	A
horizon 901 RT	1245 x 971 x 532	750 x 337	405	200F	300	81,6	7 → 9	0,08	27,70	A
horizon 1000 fond droit ou fond conique	1265 x 1088 x 610	896 x 390	405	200	350	71	13,5 → 20	0,06	51,00	A
horizon 1100	1478 x 1202 x 610	1010 x 390	510	250	450	78	11,5 → 17	0,23	75,00	A
horizon 1300	1478 x 1312 x 610	1120 x 390	510	250	480	78	11,5 → 17	0,23	75,00	A
horizon 1400	1478 x 1422 x 610	1230 x 390	510	250	510	73	12 → 18	0,23		A
vertivision										
vertivision 900	1884 x 790 x 659	598 x 445	994	250	410	73	12 → 18	0,42	34,30	A

foyers multifaces multisided fireplaces										
latéral										
latéral 800	1387 x 903 x 585	700 x 367	465	200	250	73	9 → 13,5	0,14	28,00	A
latéral 800 technika	1465 x 894 x 654	607 x 347	530	250F	290	77	9 → 13	0,056	23,00	A
latéral 900	1557 x 973 x 613	770 x 390	564	250	330	75	9,5 → 14	0,11	27,00	A
latéral horizon 901	1269 x 1005 x 563	800 x 340	407	200	300	71,4	11,5 → 17,3	0,12	56,40	A
latéral horizon 1000	1445 x 1076 x 650	890 x 464	490	300	380	78	11,5 → 17	0,23	75,00	A
3 faces										
3 faces 800	1368 x 974 x 618	750 x 367	450	200	265	73	9 → 13,5	0,14	28,00	A
3 faces 800 technika	1465 x 894 x 654	646 x 347	530	250F	280	77	9 → 13	0,056	23,00	A
3 faces 900	1583 x 962 x 661	738 x 410	535	250	295	75	9,5 → 14	0,11	27,00	A
3 faces horizon 901	1349 x 1074 x 591	850 x 340	443	250	310	71,4	9,5 → 14	0,12	56,00	A
3 faces horizon 1000	1493 x 1164 x 715	940 x 464	490	300	380	78,0	11,5 → 17	0,23	75,00	A
épi 900 technika	1507 x 676 x 972	428 x 665	545	250	300	77	9 → 13	0,056	23,00	A

synoptic of the totem range

poignée / Handles <i>acier brossé ou noir</i> <i>Brushed steel or Black steel</i>				briques / bricks						options		
galbée 120 mm curved 120 mm	droite 120 mm straight 120 mm	droite 350 mm straight 350 mm	droite 445 mm straight 445 mm	5.5 x 22 claires sans joints 5.5 x 22 yellow without seam	5.5 x 22 claires avec joints 5.5 x 22 yellow with seam	5.5 x 22 noires sans joints 5.5 x 22 black without seam	11 x 22 claires sans joints 11 x 22 yellow without seam	11 x 22 claires avec joints 11 x 22 yellow with seam	11 x 22 noires sans joints 11 x 22 black without seam	boîte à fumée smoke box	socle surbaissé 12 cm lowered base 12 cm	fer de soutien de hotte hood support iron
	●			○	○	○	●	●	○	○	●	○
				○		○	●		○			○
	●			○	○	○	●	●	○	○	●	○
	●			○	○	○	●	●	○	○	●	○
	●			○	○		●	●	○	○	○	○
	●						●	●	○	○	○	○
	●						●	●	○	○	○	○
				○		○	●		○			○
		●		○		○	●		○	○	○	○
		●		○		○	●		○	○	○	○
		●					●		○	○	○	○
			●				●		○	○	○	○
			●				●		○	○	○	○
	●			○	○	○	●	●	○	○	●	○



	●			○	○	○	●	●	○	○	○	○
		●		○		○	●		○			○
	●			○	○	○	●	●	○	○	○	○
		●		○		○	●		○	○	○	○
	●			○	○	○	●	●	○	○	○	○
		●		○		○	●		○	○	○	○
			●				●		○	○	○	○
			●				●		○	○	○	○
	●			○	○	○	●	●	○	○	○	○



synoptique de la gamme totem

● Equipement de base
By default- Free

○ En option
Option- Charged

Disponibles en 2 coloris
Available in 2 colours



dimensions en cm / dimensions in cm					performances / Performance					
dimensions hors tout : hauteur x largeur x profondeur buitenaafmetingen: hoogte x breedte x diepte	âtre : largeur x profondeur hearth: width x depth	hauteur de vision de feu Fire viewing height	Ø sortie de fumées Ø Smoke vent	poids en kg Weight in kg	rendement en % Yield in %	puissance annoncée en kW Stated power in kW	Taux de CO en % Rate of CO in %	taux poussière en mg/nm ³ Rate of dust in mg/nm ³	Classe d'efficacité énergétique Energy Efficiency Class	

foyers galbés | curved fireplaces

panoramique 900	1567 x 936 x 723	700 x 530	545	250	330	75	9,5 → 14	0,29	27,00	A
galbé latéral 900	1358 x 886 x 553	700 x 367	460	200	320	75	9,5 → 14	0,11	27,00	A
galbé latéral horizon 1000	1358 x 1076 x 650	890 x 464	460	250	360	78	11,5 → 17	0,23	75	A

foyers recto-verso séparatifs | separating double sided fireplaces

R° frontal 900 - V° battant	1589 x 968 x 712	750 x 517	570	250	375	75	9,5 → 14	0,11	27,00	A
R° frontal 1000 - V° battant	1668 x 1108 x 762	890 x 567	605	300	425	71	13,5 → 20	0,06	51,00	A
R° horizon 901 - V° battant	1265 x 968 x 588	750 x 390	405	200	250	71,4	11,5 → 17,3	0,12	56,40	A
R° horizon 1000 - V° battant	1265 x 1133 x 644	896 x 440	405	200	300	71	13,5 → 20	0,06	51,00	A
R° horizon 1100 - V° battant	1478 x 1228 x 644	1010 x 440	510	250	450	78	11,5 → 17	0,23	75	A
R° vertivision 900 - V° battant	1884 x 816 x 707	598 x 512	994	250	410	74	8 → 12	0,42	34,30	A

foyers recto-verso centraux | central double sided fireplaces

R° - V° frontal 900	1598 x 942 x 748	750 x 517	570	250	395	75	9,5 → 14	0,11	27,00	A
R° - V° frontal 1000	1668 x 1082 x 798	890 x 567	605	300	445	71	13,5 → 20	0,06	51,00	A

foyers suspendus | suspended fireplaces

4 faces suspendu 700	1831 x 770 x 743		550	250	250	78	13,5 → 20	0,19		A
4 faces suspendu 700 avec sole foyer / with hearth floor	1831 x 770 x 743	606 x 606	550	250	370	78	13,5 → 20	0,19		A
4 faces suspendu 800	1920 x 843 x 870		590	250	270	78	13,5 → 20	0,19		A
4 faces suspendu 800 avec sole foyer / with hearth floor	1920 x 843 x 870	706 x 706	590	250	390	78	13,5 → 20	0,19		A
panoramique 900 suspendu	1845 x 898 x 847		545	250	240	78	13,5 → 20	0,19		A
panoramique 900 suspendu avec sole foyer / with hearth floor	1885 x 847 x 847	Ø 750	545	250	360	78	13,5 → 20	0,19		A
4 faces suspendu 700 technika	1765 x 715 x 781	575 x 575	545	250	260	79%	de 11,5 à 16,9	0,18%	80	A
4 faces suspendu 800 technika	1765 x 825 x 891	685 x 685	545	250	310	79%	de 11,5 à 16,9	0,18%	80	A

synoptic of the totem range

poignée / Handles <i>acier brossé ou noir</i> <i>Brushed steel or Black steel</i>				briques / bricks						options		
galbée 120 mm curved 120 mm	droite 120 mm straight 120 mm	droite 350 mm straight 350 mm	droite 445 mm straight 445 mm	5.5 x 22 claires sans joints 5.5 x 22 yellow without seam	5.5 x 22 claires avec joints 5.5 x 22 yellow with seam	5.5 x 22 noires sans joints 5.5 x 22 black without seam	11 x 22 claires sans joints 11 x 22 yellow without seam	11 x 22 claires avec joints 11 x 22 yellow with seam	11 x 22 noires sans joints 11 x 22 black without seam	boîte à fumée smoke box	socle surbaissé 12 cm lowered base 12 cm	fer de soutien de hotte hood support iron
●	●			●	●	○				○	○	○
●	●			●	●	○				○	○	○
			●				●		○	○	○	○



	●			○	○	○	●	●	○	○	○	○
	●						●	●	○	○	○	○
		●		○		○	●	●	○	○	○	○
		●					●		○	○	○	○
	●		●	○	○	○	●	●	○	○	●	○



	●			○	○	○	●	●	○	○	○	○
	●						●	●	○	○	○	○



	●											○
	●						●		○			○
	●											○
	●						●		○			○
●	●											○
●	●						●		○			○
	●						●		○			○
	●						●		○			○



schéma **dynamique** *dynamic drawing*

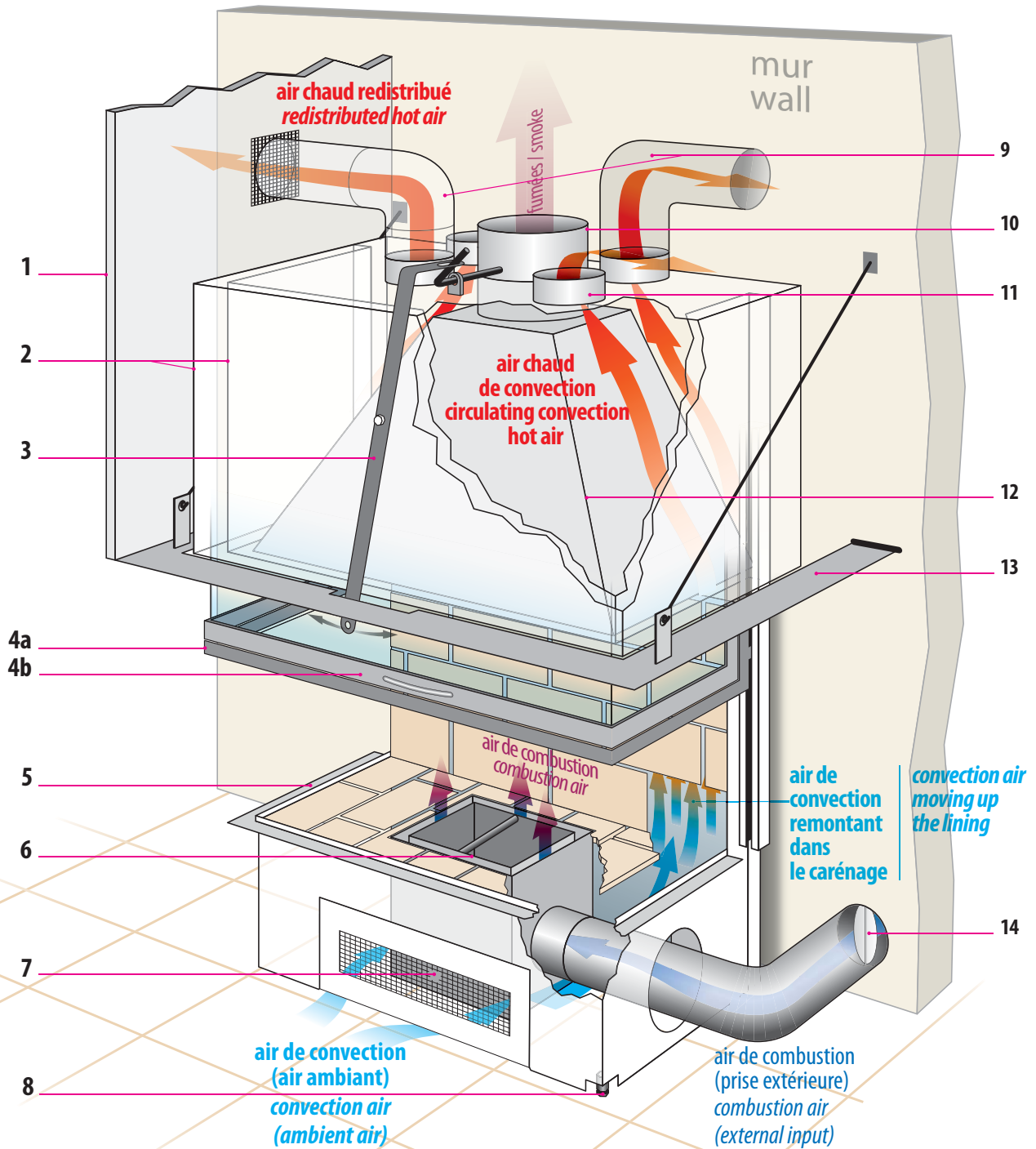

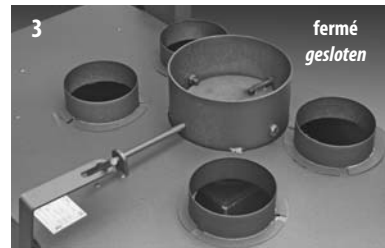
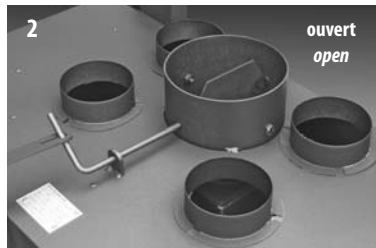

- 1- habillage de la hotte
- 2- double carénage du foyer (boîte à fumée)
- 3- manette de commande du registre des fumées - (photos 1,2,3)
- 4a- porte escamotable
- 4b- partie battante de la porte (nettoyage de la vitre) - (photo 8)
- 5- bavette d'appui (étanchéité porte fermée)
- 6- cendrier extractible équipé d'une grille à ouverture réglable - (photos 4,5,6,7)
- 7- caisson du cendrier (avec prédécoupe des arrivées d'air de combustion) - (photo 9)
- 8- vis de réglage de niveau
- 9- gaine d'air chaud (non fournie)
- 10- sortie des fumées (avec registre))
- 11- 4 sorties d'air chaud - (photos 2,3)
- 12- avaloir
- 13- fer de soutien de hotte (en option)
- 14- Registre à clapet de commande d'arrivée de l'air extérieur (en option)

- 1- Extractor covering
- 2- double lining of the fireplace (smoke box)
- 3- control lever for smoke damper - (pictures 1,2,3)
- 4a- foldaway door
- 4b- opening part of the door, for cleaning the screen - (picture 8)
- 5- support fender (sealed with door closed)
- 6- removable ash tray fitted with a grill with adjustable opening - (pictures 4,5,6,7)
- 7- ash tray box (with combustion air inputs pre-cut) - (picture 9)
- 8- level adjustment screw
- 9- hot air casing (not supplied)
- 10- smoke vent (with damper)
- 11- 4 hot air vents (pictures 2,3)
- 12- trap
- 13- hood support iron (optional)
- 14- Damper with outside air intake control valve (available as an optional extra)

schéma **dynamique** *dynamic drawing*

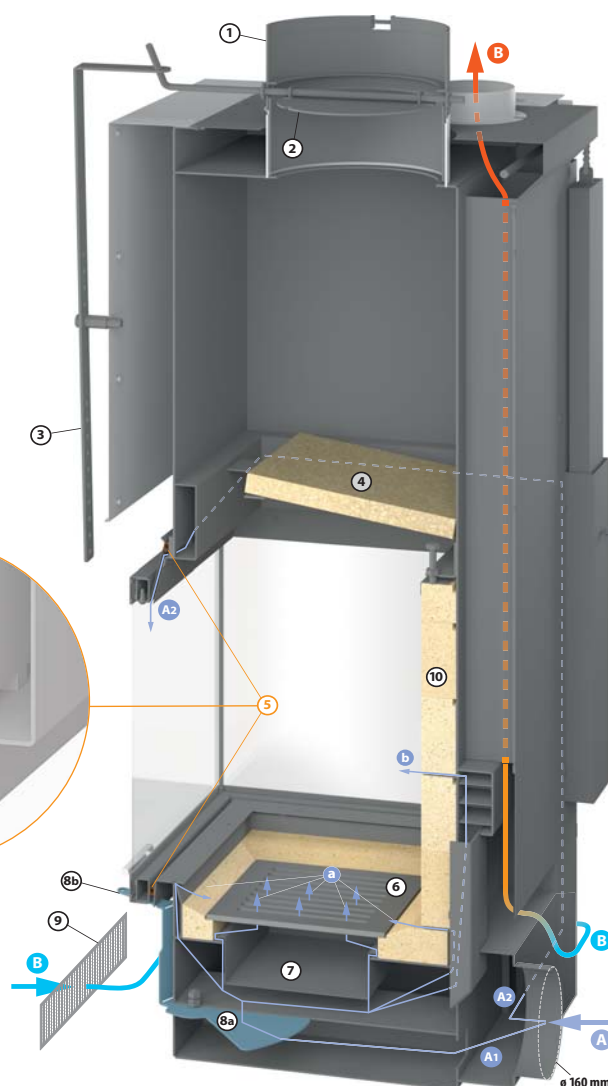

Principe de fonctionnement

- ① registre des fumées
- ② clapet de réglage des sorties de fumées (en option)
- ③ manette de commande du clapet (si clapet)
- ④ déflecteur en vermiculite
- ⑤ système de joints d'étanchéité de la porte
- ⑥ grille en fonte
- ⑦ cendrier extractible
- ⑧a diaphragme d'arrivée d'air primaire
- ⑧b manette de réglage d'arrivée d'air primaire
- ⑨ grille d'arrivée d'air de convection (non fournie)
- ⑩ briques
- A arrivée d'air extérieur qui se sépare en 2 directions
- A1 Air primaire passant par le diaphragme de réglage (manette +/- en bas de la porte) et qui se répartit en : a air de combustion (grille du cendrier / périphérie de la sole foyère) b air de double combustion (entre les briques verticales de l'âtre)
- A2 Air secondaire circulant à la verticale des vitres et retardant l'effet de noircissement.
- B B L'air de convection (air ambiant pris dans la pièce) arrive par la grille basse de l'habillage (installée à la pose) et circule dans le double carénage pour être chauffé et expulsé par les 4 sorties supérieures d'air chaud.

Operating principle

- ① Smoke damper
- ② Smoke damper flap control (optional)
- ③ Flap control handle (if there is a flap control)
- ④ Vermiculite deflector
- ⑤ Seal system of the door
- ⑥ Grate in cast iron
- ⑦ Removable ashtray
- ⑧a Primary air entry diaphragm
- ⑧b Primary air entry handle
- ⑨ Convection air entry grate (not supplied)
- ⑩ bricks
- A Fresh air entry which is divided in 2 directions
- A1 Primary air passing through the control diaphragm (handle +/- located in the bottom of the door) and is divided up in: a combustion air (ashtray grate / hearth floor rim) b double combustion air (between the vertical bricks of the fireplace)
- A2 Secondary air circulating at the upright position of the glasses and postponing their darkening.
- B B Convection air (ambient air taken from the room) coming from the low grate of the surround (installed during the fitting) and circulates in the double lining to be heated and expelled out by 4 hot air superior vents.



TU TEM



Les gammes Totem représentent aujourd'hui
49 modèles de foyers et inserts...
 ...nous sommes sûrs que vous y trouverez **le vôtre**.

the Totem range now includes
49 models of fireplaces...
 ...we are sure that you'll find **yours** amongst them.

TOTEM

TOTEM FIRE SAS
 4, avenue du Guimand
 F-26120 MALISSARD / Valence - Drôme
 tél. (33) 0 4 75 40 18 89 / fax : (33) 0 4 75 41 08 39
 commercial@totemfire.com



www.totemfire.com

votre revendeur | Your dealer